

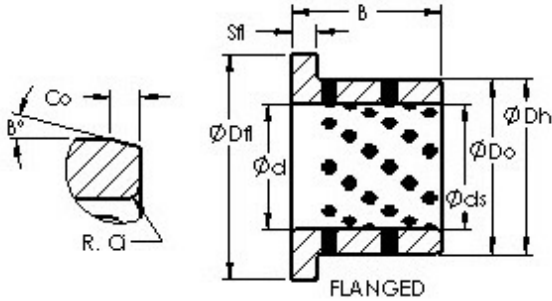

Shandong Chik Bearing Co., Ltd.

AST AST650 F162230 plain bearings

Bearing No. AST650 F162230



AST650 F162230 Bearing 2D drawings and 3D CAD models

Bore Diameter	16 mm
Outer Diameter	22 mm
Bearing Type	flanged
Shaft Dia., Nominal (d)	16.0000
Housing Bore Dia. (Dh) - 22 +0.021 / -0	22 +0.021 / 0
Bearing Outside Diameter, Nominal(Do)	22.000
Bearing Outside Diameter Tolerance (Do tol.)	22 +0.021 / +0.008
Bearing Bore after Mounting (di)	16 +0.034 / +0.016
Bearing Length, Nominal (B)	30.000
Bearing Length Tolerance (B tol.) - -0.10 / -0.30	0.10 / 0.30
OD Chamfer Length (Co)	2.000
ID Chamfer Angle (B deg.)	15
ID Chamfer Length (Ci)	1.200
Flange Dia. (Dfl pm 0.5)	29.000
Material	Cast bronze with solid lubricant inserts.