

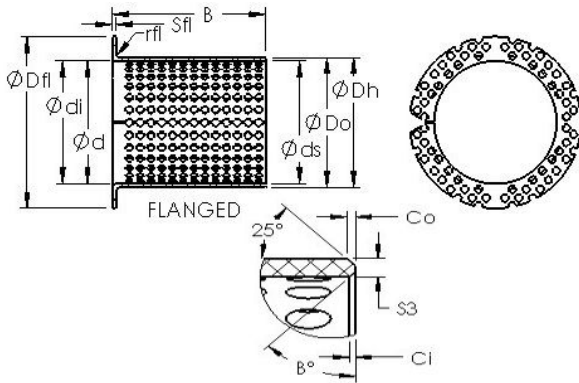

Shandong Chik Bearing Co., Ltd.



AST ASTT90 F6030 plain bearings

Bearing No. ASTT90 F6030

| | |
|---|--|
| Bore Diameter | 60 mm |
| Outer Diameter | 65 mm |
| Bearing Type | flanged |
| Shaft Dia., Nominal (d) | 60.0000 |
| Shaft Size (ds) - 60 -0.100 / -0.130 | 60 0.100 / 0.130 |
| Housing Bore Dia. (Dh) - 65 +0.030 / -0 | 65 +0.030 / 0 |
| Bearing Outside Diameter, Nominal(Do) | 65.000 |
| Bearing Bore after Mounting (di) - 60 +0.074 / -0 | 60 +0.074 / 0 |
| Wall Thickness (S3) | 2.500 |
| Bearing Length, Nominal (B) | 30.000 |
| Bearing Length Tolerance (B tol.) - +0 / -0.40 | +0 / 0.40 |
| OD Chamfer Length (Co) | 1.800 |
| ID Chamfer Angle (B deg.) | 45 |
| ID Chamfer Length (Ci) | 0.600 |
| Flange Dia. (Dfl pm 0.5) | 75.000 |
| Flange Thickness (Sfl) | 2.500 |
| Flange Radius (rfl) | 2.000 |
| Material | Wrapped bronze with lubrication holes. |

ASTT90 F6030 Bearing 2D drawings and 3D CAD models