

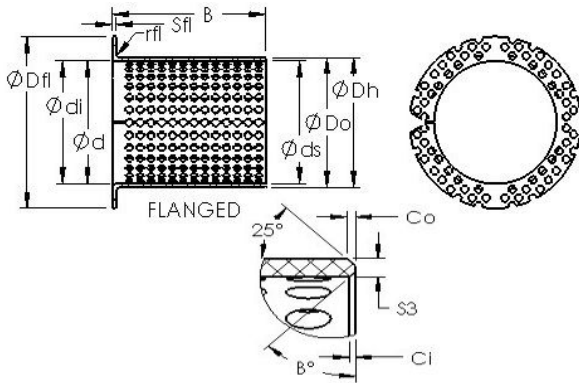

Shandong Chik Bearing Co., Ltd.



AST ASTT90 F5040 plain bearings

Bearing No. ASTT90 F5040

Bore Diameter	50 mm
Outer Diameter	55 mm
Bearing Type	flanged
Shaft Dia., Nominal (d)	50.0000
Shaft Size (ds) - 50 -0.080 / -0.105	50 0.080 / 0.105
Housing Bore Dia. (Dh) - 55 +0.030 / -0	55 +0.030 / 0
Bearing Outside Diameter, Nominal(Do)	55.000
Bearing Bore after Mounting (di) - 50 +0.062 / -0	50 +0.062 / 0
Wall Thickness (S3)	2.500
Bearing Length, Nominal (B)	40.000
Bearing Length Tolerance (B tol.) - +0 / -0.40	+0 / 0.40
OD Chamfer Length (Co)	1.800
ID Chamfer Angle (B deg.)	45
ID Chamfer Length (Ci)	0.600
Flange Dia. (Dfl pm 0.5)	65.000
Flange Thickness (Sfl)	2.500
Flange Radius (rfl)	2.000
Material	Wrapped bronze with lubrication holes.

ASTT90 F5040 Bearing 2D drawings and 3D CAD models